

◆ 选型 Type Selection

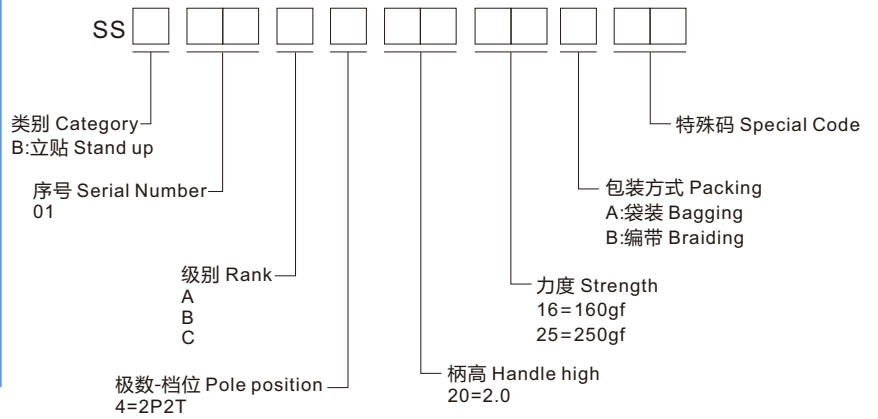

◆ 规格 Specifications

- 接触额定值 Contact Rating : 0.3A 4V DC
- 接触电阻 Contact Resistance : $\leq 100m\Omega$
- 绝缘电阻 Insulation Resistance : $\geq 100M\Omega$.500V DC
- 电介质 Dielectric : $\geq 500V$ AC/1 minute
- 电气寿命 Electric Life : ≥ 10000 cycles
- 工作温度 Operating Temp : $-20^{\circ}C \sim +70^{\circ}C$
- 存储温度 Storage Temp : $-40^{\circ}C \sim +85^{\circ}C$

◆ 材质 Material

- 触点 Contacts : 铜合金 Copper Alloy
- 本体 Ontology : PPA/LCP
- 外壳 Housing : 铜合金 Copper Alloy
- 按钮 Button : PPA

◆ 图表 Diagram

■ SSB01A420

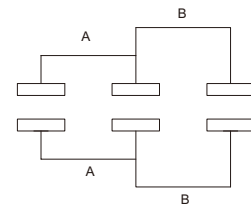
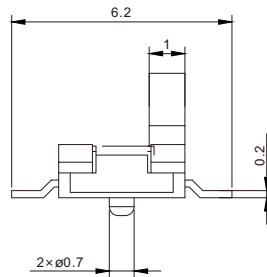
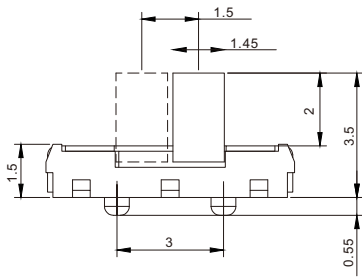

电路图
Circuit diagram

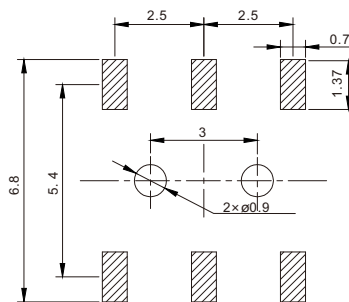
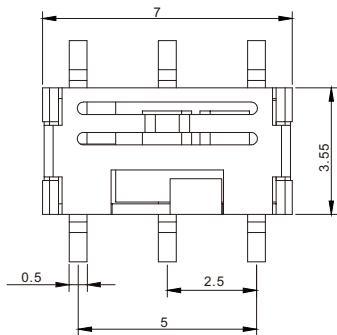

安装图
instructions